

## STAINLESS STEEL GROOVED END FITTINGS



For pressure rating, listing, and approval information, refer to data sheet or visit SHURJOINT website [www.shurjoint.com](http://www.shurjoint.com) for details or contact your SHURJOINT representatives.

The Shurjoint cast stainless steel grooved fittings are investment cast in sizes 1" - 12". These fittings are supplied in ASTM A351 or A743 austenitic grades CF8 (304) and CF8M (316). Materials are in compliance with NSF/ANSI 61/372 for potable water service applications. In addition, fittings are also available on request in CF3M (316L), 316Ti, 2205 Duplex, 2507 Super Duplex and ASTM CK-3McuN (UNS J93245) the cast equivalent to 254SMO\* to meet your specific service requirements. All cast fittings feature full flow characteristics and are designed to the same dimensions of standard ductile iron grooved fittings.

The Shurjoint wrought stainless steel grooved end fittings are fabricated with type 304 stainless steel pipe or are segmentally welded. Dimensions conform to ANSI B16.9 unless specified.

\*254SMO is a registered trademark of Avesta Polarit AB.

Shurjoint cast fitting pressure ratings are equivalent to the pressure ratings (with Schedule 40 pipe) of the coupling used to install them. When installed on Shurjoint wrought fittings, the Shurjoint coupling pressure ratings are dependent on the pipe/fitting wall thickness

### material specification

- Fitting Body:**

Cast fittings: Type 304 stainless steel to ASTM A351 CF8 or A743 Gr. CF8

- Type 316 to ASTM A743 CF8M
- Type 316L to ASTM A743 CF3M
- Type 316Ti to ASTM A240.
- Duplex 2205 to ASTM A890 4A
- Super Duplex 2507 to ASTM A890 5A
- Duplex 254SMO to ASTM A351 CK3McuN

Wrought fittings: Type 304 stainless steel conforming to ASTM A312/A312M. Sch. 40S (up to 6") or Sch. 20S (8" to 12") or STD (14" and up) wall thickness for grooved end as standard. Sch. 40S wall thickness for male threaded end as standard. F304 stainless steel flange conforming to ASTM 182/182M.

**MODEL SS-10 90° ELBOW**  
**SS-11 45° ELBOW**  
**SS-20 TEE**  
**SS-60 CAP**

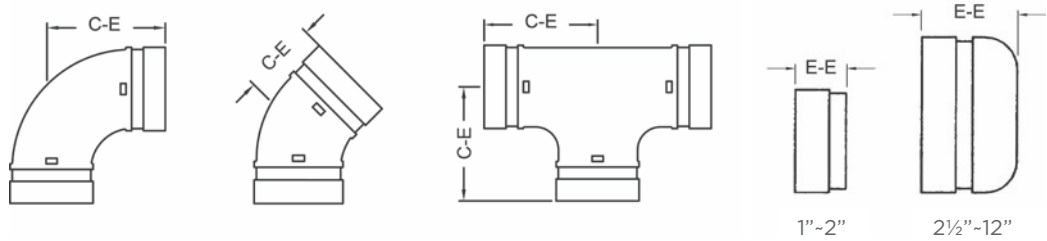

Model SS-10 / SS-11 / SS-20 / SS-60 Stainless Steel Fittings

Nominal Size	Pipe O.D.	SS-10 90° Elbow		SS-11 45° Elbow		SS-20 Tee		SS-60 Cap	
		C-E	Weight	C-E	Weight	C-E	Weight	E-E	Weight
in	in	in	lbs	in	lbs	in	lbs	in	lbs
mm	mm	mm	kg	mm	kg	mm	kg	mm	kg
1	1.315	2.25	0.7	1.75	0.4	2.25	0.9	0.94	0.2
25	33.4	57	0.3	45	0.2	57	0.4	24	0.1
1¼	1.660	2.75	0.9	1.75	0.7	2.75	1.5	0.94	0.2
32	42.2	70	0.4	45	0.3	70	0.7	24	0.1
1½	1.900	2.75	0.9	1.75	0.9	2.75	1.8	0.94	0.4
40	48.3	70	0.4	45	0.4	70	0.8	24	0.2
2	2.375	3.25	1.3	2.00	1.1	3.25	2.4	0.94	0.4
50	60.3	83	0.6	51	0.5	83	1.1	24	0.2
2½	2.875	3.75	3.1	2.10	2.2	3.75	5.5	1.75	0.9
65	73.0	95	1.4	54	1.0	95	2.5	45	0.4
76.1	3.000	3.75	3.5	2.25	2.2	3.75	5.5	1.75	0.9
	76.1	95	1.6	57	1.0	95	2.5	45	0.4
3	3.500	4.25	2.9	2.50	2.2	4.25	4.6	2.00	1.5
80	88.9	108	1.3	64	1.0	108	2.1	51	0.7
4	4.500	5.00	4.8	3.00	3.5	5.00	7.5	2.00	2.0
100	114.3	127	2.2	76	1.6	127	3.4	51	0.9
139.7	5.500	5.50	8.6	3.25	6.2	5.50	12.3	2.38	3.5
	139.7	140	3.9	83	2.8	140	5.6	60	1.6
5	5.563	5.50	8.6	3.25	6.4	5.50	12.8	2.38	3.3
125	141.3	140	3.9	83	2.9	140	5.8	60	1.5
165.1	6.500	6.50	13.6	3.50	9.0	6.50	19.8	3.00	5.7
	165.1	165	6.2	89	4.1	165	9.0	76	2.6
6	6.625	6.50	14.3	3.50	9.2	6.50	21.3	3.00	5.3
150	168.3	165	6.5	89	4.2	165	9.7	76	2.4

STAINLESS STEEL GROOVED END FITTINGS  
 Rev.2025.0318

Model SS-10 / SS-11 / SS-20 / SS-60 Stainless Steel Fittings

Nominal Size	Pipe O.D.	SS-10 90° Elbow		SS-11 45° Elbow		SS-20 Tee		SS-60 Cap	
		C-E	Weight	C-E	Weight	C-E	Weight	E-E	Weight
in	in	in	lbs	in	lbs	in	lbs	in	lbs
mm	mm	mm	kg	mm	kg	mm	kg	mm	Kg
8	8.625	7.75	23.5	4.25	15.6	7.75	41.4	3.50	11.4
200	219.1	197	10.7	108	7.1	197	18.8	90	5.2
10	10.750			6.26	37.0			5.00	22.4
250	273.0			159	16.8			127	10.2
12	12.750							6.00	32.3
300	323.9							154	14.7
200 JIS	8.516	7.75	24.6	4.25	15.6	7.75	30.4	3.50	9.2
	216.3	197	11.2	108	7.1	197	13.8	90	4.2
250 JIS	10.528			6.26	37.0			5.00	19.6
	267.4			159	16.8			127	8.9
300 JIS	12.539							6.00	29.7
	318.5							154	13.5

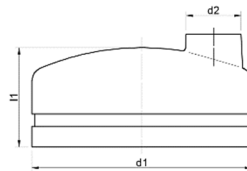

Model SS-60T Transition Cap

Nominal Size	Pipe O.D.	NPT / BSP	L	Weight
in	in	in	in	lbs
mm	mm	mm	mm	kg
2½	2.875	½	1.77	0.55
50	73.0	15	45	0.25
3	3.500	½	2.01	0.97
80	88.9	15	51	0.44
4	4.500	1	2.01	1.3
100	114.3	25	51	0.6
6	6.625	1	2.99	2.09
150	168.3	25	76	0.95

STAINLESS STEEL GROOVED END FITTINGS  
Rev.20250318

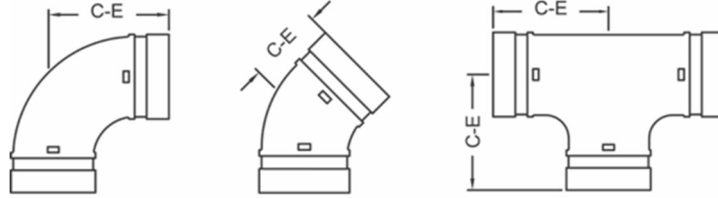

Model WS-10LR / WS-11LR / WS-20 Wrought Stainless Steel Fittings

Nominal Size	Pipe O.D.	WS-10LR 90° Elbow		WS-11LR 45° Elbow		WS-20 Tee	
		C-E	Weight	C-E	Weight	C-E	Weight
in	in	in	lbs	in	lbs	in	lbs
mm	mm	mm	kg	mm	kg	mm	kg
10	10.750	15.00	51.9	--	--	8.90*	42.9
250	273.0	381	23.6	--	--	226	19.5
12	12.750	18.00	74.6	7.50	28.4	10.40*	58.9
300	323.9	457	33.9	190	16.9	264	26.8

\*Does not conform to ANSI B16.9

**MODEL SS-21 REDUCING TEE  
SS-50 CONCENTRIC REDUCER**

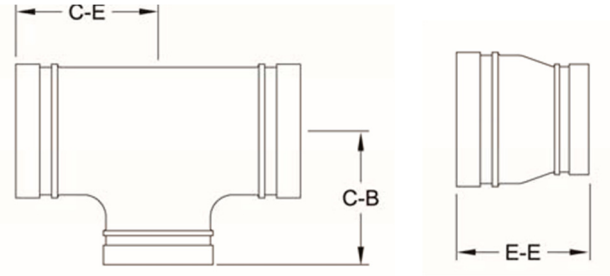

Model SS-21 Reducing Tee, SS-50 Concentric Reducer

Nominal Pipe Size	Pipe O.D.	SS-21 Reducing Tee		Weight	SS-50 Concentric Reducer	
		C-E	C-B		E-E	Weight
in	in	in	in	lbs	in	lbs
mm	mm	mm	mm	kg	mm	kg
1¼ x 1	1.660 x 1.315	2.75	2.75	1.2	2.50	0.5
30 x 25	42.2 x 33.4	70	70	0.6	64	0.2
1½ x 1	1.900 x 1.315	2.75	2.75	1.3	2.50	0.6
40 x 25	48.3 x 33.4	70	70	0.6	64	0.3
1½ x 1¼	1.900 x 1.660	2.75	2.75	1.3	2.50	0.7
40 x 32	48.3 x 42.2	70	70	0.6	64	0.3
2 x 1	2.375 x 1.315	2.75	2.75	1.5	2.50	0.8
50 x 25	60.3 x 33.4	70	70	0.7	64	0.3
2 x 1¼	2.375 x 1.660	2.75	2.75	1.8	2.50	0.7
50 x 32	60.3 x 42.2	70	70	0.8	64	0.7
2 x 1½	2.375 x 1.900	2.75	2.75	1.8	2.50	0.7
50 x 40	60.3 x 48.3	70	70	0.8	64	0.3
2½ x 1	2.875 x 1.315	3.75	3.75	2.0	2.50	0.9
65 x 25	73.0 x 33.4	95	95	0.9	64	0.4
2½ x 1¼	2.875 x 1.660	3.75	3.75	2.0	2.50	1.1
65 x 32	73.0 x 42.2	95	95	0.9	64	0.5
2½ x 1½	2.875 x 1.900	3.75	3.75	2.0	2.50	1.2
65 x 40	73.0 x 48.3	95	95	0.9	64	0.5
2½ x 2	2.875 x 2.375	3.00	3.00	4.1	2.50	1.1
65 x 50	73.0 x 60.3	76	76	1.9	64	0.5
76.1 mm x 25	3.000 x 1.315	3.75	3.75	2.0	2.50	0.9
	76.1 x 33.4	95	95	0.9	64	0.4
76.1 mm x 32	3.000 x 1.660	3.75	3.75	2.0	2.50	1.1
	76.1 x 42.2	95	95	0.9	64	0.5
76.1 mm x 40	3.000 x 1.900	3.75	3.75	2.0	2.50	1.2
	76.1 x 48.3	95	95	0.9	64	0.5

STAINLESS STEEL GROOVED END FITTINGS  
Rev.2025.0318

Model SS-21 Reducing Tee, SS-50 Concentric Reducer						
Nominal Size	Pipe O.D.	SS-21 Reducing Tee		Weight	SS-50 Concentric Reducer	
		C-E	C-B		E-E	Weight
in	in	in	in	lbs	in	lbs
mm	mm	mm	mm	kg	mm	kg
76.1 mm x 50	3.000 x 2.375	3.00	3.00	3.3	2.50	1.1
	76.1 x 60.3	76	76	1.5	64	0.5
3 x 1¼	3.500 x 1.660	4.25	4.25	3.5	2.50	1.1
80 x 32	88.9 x 42.2	108	108	1.6	64	0.5
3 x 1½	3.500 x 1.900	4.25	4.25	2.9	2.50	1.5
80 x 40	88.9 x 48.3	108	108	1.3	64	0.6
3 x 2	3.500 x 2.375	4.25	4.25	4.6	2.50	1.3
80 x 50	88.9 x 60.3	108	108	2.1	64	0.6
3 x 2½	3.500 x 2.875	3.75	3.25	6.0	3.50	2.2
80 x 65	88.9 x 73.0	95	83	2.7	89	1.0
80 x 76.1 mm	3.500 x 3.000	3.75	3.25	4.6	3.50	2.2
	88.9 x 76.1	95	83	2.1	89	1.0
4 x 2	4.500 x 2.375	5.00	5.00	7.3	3.00	2.2
100 x 50	114.3 x 60.3	127	127	3.3	76	1.0
4 x 2½	4.500 x 2.875	4.49	3.86	8.8	4.00	3.1
100 x 65	114.3 x 73.0	114	98	4.0	102	1.4
100 x 76.1 mm	4.500 x 3.000	4.49	3.86	9.0	4.00	3.1
	114.3 x 76.1	114	98	4.1	102	1.4
4 x 3	4.500 x 3.500	4.49	3.86	7.0	3.00	2.0
100 x 80	114.3 x 88.9	114	98	3.2	76	0.9
139.7 x 76.1	5.563 x 3.000	5.50	5.50	11.2	3.50	3.5
125 x 65	139.7 x 76.1	140	140	5.1	89	1.6
139.7 x 80	5.563 x 3.500	5.50	5.50	11.2	3.50	3.5
125 x 80	139.7 x 88.9	140	140	5.1	89	1.6
139.7 x 100	5.500 x 4.500	5.50	5.50	11.2	3.50	3.5
125 x 100	139.7 x 114.3	140	140	5.1	89	1.6
5 x 2½	5.563 x 2.875	5.50	5.50	11.2	3.50	3.5
125 x 65	141.3 x 73.0	140	140	5.1	89	1.6
5 x 3	5.563 x 3.500	5.50	5.50	11.2	3.50	3.5
125 x 80	141.3 x 88.9	140	140	5.1	89	1.6
5 x 4	5.563 x 4.500	5.50	5.50	11.2	3.50	3.5
125 x 100	141.3 x 114.3	140	140	5.1	89	1.6
165.1 x 80	6.500 x 3.500	5.91	5.91	15.6	4.00	5.1
	165.1 x 88.9	150	150	7.1	102	2.3
165.1 x 100	6.500 x 4.500	6.50	6.50	19.4	4.00	5.1
	165.1 x 114.3	165	165	8.8	102	2.3

STAINLESS STEEL GROOVED END FITTINGS  
Rev.20250318

Model SS-21 Reducing Tee, SS-50 Concentric Reducer						
Nominal Size	Pipe O.D.	SS-21 Reducing Tee		Weight	SS-50 Concentric Reducer	Weight
		C-E	C-B		E-E	
in	in	in	in	lbs	in	lbs
mm	mm	mm	mm	kg	mm	kg
165.1 x 139.7	6.500 x 5.500	6.50	6.50	19.4	4.00	5.7
	165.1 x 139.7	165	165	8.8	102	2.6
6 x 2*	6.625 x 2.375	5.63	4.75	15.4	--	--
150 x 50	168.3 x 60.3	143	121	7.0	--	--
6 x 3	6.625 x 3.500	5.91	5.91	15.6	4.00	5.1
150 x 80	168.3 x 88.9	150	150	7.1	102	2.3
6 x 4	6.625 x 4.500	6.50	6.50	19.4	4.00	5.1
150 x 100	168.3 x 114.3	165	165	8.8	102	2.3
6 x 5	6.625 x 5.563	6.50	6.50	19.4	4.00	5.7
150 x 125	168.3 x 141.3	165	165	8.8	102	2.6
8 x 3	8.625 x 3.500	7.76	7.76	31.5	--	--
200 x 80	219.1 x 88.9	197	197	14.3	--	--
8 x 4	8.625 x 4.500	7.76	7.76	35.4	5.00	9.5
200 x 100	219.1 x 114.3	197	197	16.1	127	4.3
8 x 5	8.625 x 5.563	7.76	7.76	28.6	5.00	11.9
200 x 125	219.1x 141.3	197	197	13.0	127	5.4
8 x 6	8.625 x 6.625	7.76	7.76	54.1	5.00	9.5
200 x 150	219.1 x 168.3	197	197	24.6	127	4.3
10 x 6	10.750 x 6.625	9.02	9.02	59.2	6.00	18.3
250 x 150	273.0 x 168.3	229	229	26.9	152	8.3
10 x 8	10.750 x 8.625	9.02	9.02	60.1	6.00	19.1
250 x 200	273.0 x 219.1	229	229	27.3	152	8.7
12 x 4**	12.750 x 4.500	10.00	8.50	51.9	--	--
300 x 100	323.9 x 114.3	254	216	23.6	--	--
12 x 6**	12.750 x 6.625	10.00	8.62	52.4	--	--
300 x 150	323.9 x 168.3	254	219	23.8	--	--
12 x 8	12.750 x 8.625	--	--	--	7.00	49.5
300 x 200	323.9 x 219.1	--	--	--	178	22.0
12 x 10	12.750 x 10.750	10.00*	9.50	55.0	7.00	23.1
300 x 250	323.9 x 273.0	254	241.3	25	178	11.3
200 JIS x 100	8.516 x 4.500	7.76	7.76	35.4	5.00	9.5
	216.3 x 114.3	197	197	16.1	127	4.3
200 JIS x 125	8.516 x 5.500	7.76	7.76	28.6	5.00	11.9
	216.3 x 139.7	197	197	13.0	127	5.4
200 JIS x 165.1	8.516 x 6.500	7.76	7.76	54.1	5.00	9.5
	216.3 x 165.1	197	197	24.6	127	4.3
250 JIS x 100**	10.550 x 4.500	8.50	7.25	38.3	--	--
	267.4 x 114.3	216	184	17.4	--	--

Model SS-21 Reducing Tee, SS-50 Concentric Reducer						
Nominal Size	Pipe O.D.	SS-21 Reducing Tee		Weight	SS-50 Concentric Reducer	
		C-E	C-B		E-E	Weight
in	in	in	in	lbs	in	lbs
mm	mm	mm	mm	kg	mm	kg
250 JIS x 165.1	10.528 x 6.500	9.02	9.02	59.2	6.00	18.3
	267.4 x 165.1	229	229	26.9	152	8.3
250 JIS x 200 JIS	10.528 x 8.516	9.02	9.02	60.1	6.00	19.1
	267.4 x 216.3	229	229	27.3	152	8.7
300 JIS x 100**	12.550 x 4.500	10.00	8.50	51.9	--	--
	318.5 x 114.3	254	216	23.6	--	--
300 JIS x 200 JIS	12.539 x 8.516	--	--	--	7.00	49.5
	318.5 x 216.3	--	--	--	178	22.0
300 JIS x 250 JIS	12.539 x 10.528	--	--	--	7.00	23.1
	318.5 x 267.4	--	--	--	178	11.3

\* Fabricated.

\*\* Wrought items sold as "WS" series item.



**MODEL SS-21F REDUCING TEE (GR x GR x FT)  
SS-50F CONCENTRIC REDUCER (GR x FT)**

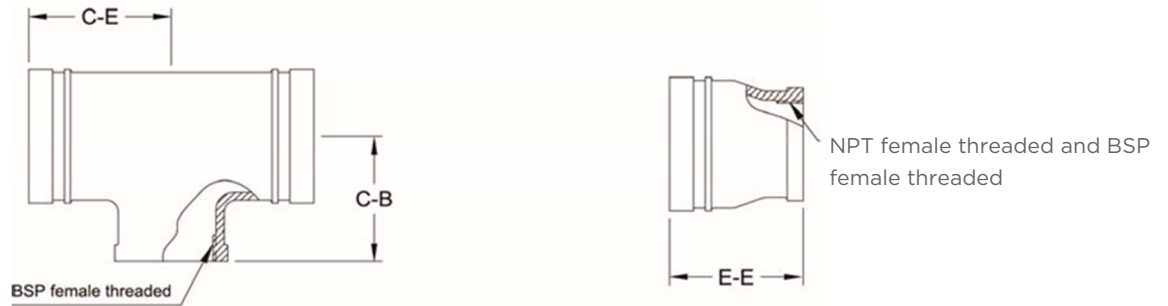

Model SS-21F Reducing Tee, SS-50F Concentric Reducer

Nominal Pipe Size	Pipe O.D.	SS-21F Reducing Tee		Weight	SS-50F Concentric Reducer	
		C-E	C-B		E-E	Weight
in	in	in	in	lbs	in	lbs
mm	mm	mm	mm	kg	mm	kg
2 x 1½*	2.375 x 1.900	2.52	2.25	1.78	--	--
50 x 40	60.3 x 48.3	64	57	0.81	--	--
2½ x 1*	2.875/3.000 x 1.315	3.00	2.25	4.12	--	--
65 x 25	73.0/76.1 x 33.4	76	57	1.87	--	--
2½ x 1½	2.875/3.000 x 1.900	3.00	3.00	1.83	--	--
65 x 40	73.0/76.1 x 48.3	76	76	0.83	--	--
2½ x 2	2.875/3.000 x 2.375	--	--	--	3.50	2.10
65 x 50	73.0/76.1 x 60.3	--	--	--	89	0.95
3 x ¾*	3.500 x 1.050	3.40	2.75	5.62	--	--
80 x 20	88.9 x 26.7	86	70	2.55	--	--
3 x 1*	3.500 x 1.315	3.40	2.75	5.84	--	--
80 x 25	88.9 x 33.4	86	70	2.65	--	--
3 x 1½*	3.500 x 1.900	3.40	2.88	6.06	--	--
80 x 40	88.9 x 48.3	86	73	2.75	--	--
3 x 2	3.500 x 2.375	3.75	3.25	4.63	3.50	2.03
80 x 50	88.9 x 60.3	95	83	2.10	89	0.92
4 x ¾*	4.500 x 1.050	4.13	3.40	9.03	--	--
100 x 20	114.3 x 26.7	105	86	4.10	--	--
4 x 1*	4.500 x 1.315	4.13	3.40	9.12	--	--
100 x 25	114.3 x 33.4	105	86	4.14	--	--
4 x 1½*	4.500 x 1.900	4.13	3.40	9.36	--	--
100 x 40	114.3 x 48.3	105	86	4.25	--	--
4 x 2	4.500 x 2.375	4.50	3.86	7.05	4.00	3.88
100 x 50	114.3 x 60.3	114	98	3.20	102	1.76
6 x ¾*	6.500/6.625 x 1.050	5.63	4.75	18.83	--	--
150 x 20	165.1/168.3 x 26.7	143	121	8.55	--	--

STAINLESS STEEL GROOVED END FITTINGS  
Rev.20250318

Model SS-21F Reducing Tee, SS-50F Concentric Reducer

Nominal Pipe Size	Pipe O.D.	SS-21F Reducing Tee		Weight	SS-50F Concentric Reducer	
		C-E	C-B		E-E	Weight
in	in	in	in	lbs	in	lbs
mm	mm	mm	mm	kg	mm	kg
6 x 1*	6.500/6.625 x 1.315	5.63	4.75	19.05	--	--
150 x 25	165.1/168.3 x 33.4	143	121	8.65	--	--
6 x 1½*	6.500/6.625 x 1.900	5.63	4.75	19.27	--	--
150 x 40	165.1/168.3 x 48.3	143	121	8.75	--	--
8 x ¾*	8.625 x 1.050	7.00	6.00	33.26	--	--
200 x 20	219.1 x 26.7	178	152	15.10	--	--
8 x 1*	8.625 x 1.315	7.00	6.00	33.37	--	--
200 x 25	219.1 x 33.4	178	152	15.15	--	--
10 x 1*	10.750 x 1.315	8.50	7.25	57.27	--	--
250 x 25	273.0 x 33.4	216	184	26.00	--	--

\* Fabricated

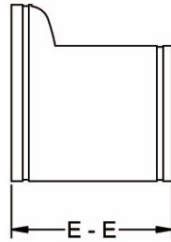

Model SS-51 Wrought Eccentric Reducer

Nominal Pipe Size	Pipe O.D.	E-E	Weight
in	in	in	in
mm	mm	mm	mm
2½ x 2*	2.875 x 2.375	3.50	1.23
65 x 50	73.0 x 60.3	89	0.56
3 x 2*	3.500 x 2.375	3.50	2.49
80 x 50	88.9 x 60.3	89	1.13
3 x 2½*	3.500 x 2.875	3.50	1.96
80 x 65	88.9 x 73.0	89	0.89
4 x 2*	4.500 x 2.375	4.00	
100 x 50	114.3 x 60.3	102	1.16
4 x 2½*	4.500 x 2.875	4.00	2.64
100 x 65	114.3 x 73.0	102	1.20
4 x 3*	4.500 x 3.500	4.00	2.86
100 x 80	114.3 x 88.9	102	1.30
5 x 4*	5.563 x 4.500	5.00	3.45
125 x 100	141.3 x 114.3	127	1.57
6 x 3*	6.625 x 3.500	5.50	6.72
150 x 80	168.3 x 88.9	140	3.05
6 x 4*	6.625 x 4.500	5.50	6.95
150 x 100	168.3 x 114.3	140	3.16
8 x 4*	8.625 x 4.500	6.00	12.89
200 x 100	219.1 x 114.3	152	5.86
8 x 6*	8.625 x 6.625	6.00	11.70
200 x 150	219.1 x 168.3	152	5.32
10 x 6*	10.750 x 6.625	7.00	22.47
250 x 150	273.0 x 168.3	178	10.20
10 x 8*	10.750 x 8.625	7.00	22.80
250 x 200	273.0 x 219.1	178	10.40
12 x 6*	12.750 x 6.625	8.00	21.10
300 x 150	323.9 x 168.3	203	9.60
12 x 8*	12.750 x 8.625	8.00	20.90
300 x 200	323.9 x 219.1	203	9.50

\* Fabricated.

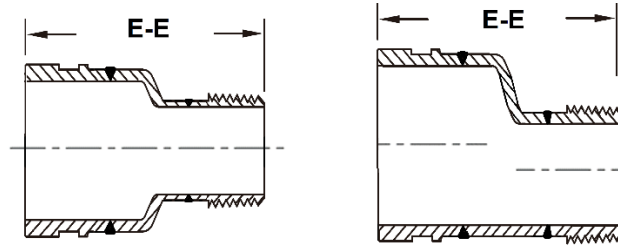

SS-50M/SS-51M Con./Ecc. Reducer

Nominal Pipe Size	Pipe O.D.	#SS-50M		#SS-51M	
		E - E	weight	E - E	E - E
in	in	in	Lbs	in	Lbs
mm	mm	mm	kgs	mm	Kgs
2 x 1	2.375 x 1.315	3.50	0.8	3.50	0.8
50 x 25	60.3 x 33.4	89	0.3	89	0.3
2 x 1½	2.375 x 1.900	3.50	0.8	3.50	0.8
50 x 40	60.3 x 48.3	89	0.3	89	0.3

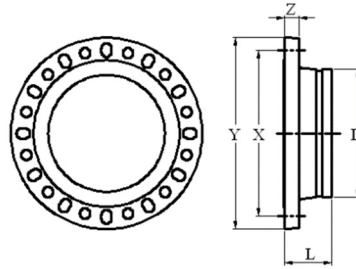

**Model SS-70 Flange Adapter ANSI Class 300 (raised face)**

Nominal Pipe Size	X	Y	Z	Bolt Size	Bolt Hole		D	L	Weight
					Dia.	No.			
in	in	in	in	in	in	Unit	in	in	Lbs
mm	mm	mm	mm	mm	mm		mm	mm	Kgs
2	5.00	6.50	0.82	5/8	3/4	8	2	2.81	9.0
50	127	165	21				60.3	71	4.1
3	6.62	8.25	1.06	3/4	7/8	8	3	3.18	15.0
80	168	210	27				88.9	81	6.8
6	10.62	12.50	1.38	3/4	7/8	12	6	3.94	42.0
150	270	318	35				168.3	100	19.1
8	13.00	15.00	1.56	7/8	1	12	8	4.44	67.0
200	330	381	40				219.1	113	30.4

**Model SS-70F Flange Adapter ANSI Class 300 (flat face)**

Nominal Pipe Size	X	Y	Z	Bolt Size	Bolt Hole		D	L	Weight
					Dia.	No.			
in	in	in	in	in	in	Unit	in	in	Lbs
mm	mm	mm	mm				mm	mm	Kgs
2	5.00	6.50	0.82	5/8	3/4	8	2	2.75	9.0
50	127	165	21				60.3	70	4.1
3	6.62	8.25	1.06	3/4	7/8	8	3	3.12	15.0
80	168	210	27				88.9	79	6.8
6	10.62	12.50	1.38	3/4	7/8	12	6	3.88	42.0
150	270	318	35				168.3	99	19.1
8	13.00	15.00	1.56	7/8	1	12	8	4.38	67.0
200	330	381	40				219.1	111	30.4

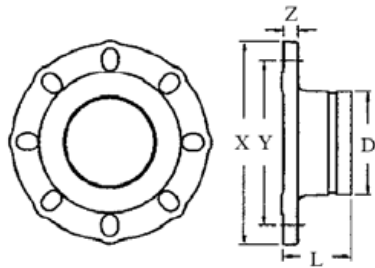

Size: 2" - 8"

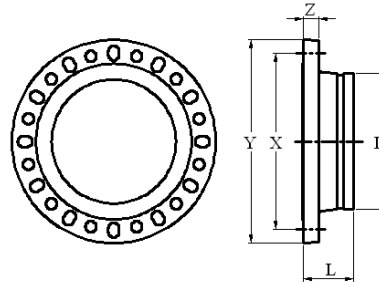

Size: 10" - 12"

**Model SS-80 Stainless Steel Universal Flange Adapter (raised face)**

Nominal Pipe Size	Pipe O.D.	L	X	Y: Flange Drilling				Z	Bolts				Weight
				ANSI 125 / 150	PN 10	PN 16	JIS 10K		ANSI 125 / 150	PN 10	PN 16	JIS 10K	
in	in	in	in	in	in	in	in	in	in	in	in	in	lbs
mm	mm	mm	mm	mm	mm	mm	mm	mm	mm	mm	mm	mm	kg
2	2.375	2.50	6.50	4.75	4.92	4.92	4.72	0.63	5/8	M16	M16	M16	4.4
50	60.3	64	165	121	125	125	120	16	4	4	4	4	2.0
2½	2.875	3.00	7.28	5.50	5.70	5.70	5.50	0.63	5/8	---	---	---	6.4
65	73.0	76	185	140	145	145	140	16	4	---	---	---	2.9
76.1	3.000	3.00	7.28	5.50	5.70	5.70	5.50	0.63	---	M16	M16	M16	6.6
	76.1	76	185	140	145	145	140	16	---	4	4	4	3.0
3	3.500	2.95	7.78	6.00	6.30	6.30	5.90	0.63	5/8	M16	M16	M16	7.5
80	88.9	75	200	152	160	160	150	16	8	8	8	8	3.4
4	4.500	2.95	8.86	7.50	7.09	7.09	6.89	0.63	5/8	M16	M16	M16	8.6
100	114.3	75	225	191	180	180	175	16	8	8	8	8	3.9
139.7	5.500	2.95	10.00	8.50	8.27	8.27	8.27	0.63	---	M16	M16	M20	14.7
	139.7	75	254	216	210	210	210	16	---	8	8	8	6.7
5	5.563	2.95	10.00	8.50	8.27	8.27	8.27	0.87	¾	---	---	---	14.7
125	141.3	75	254	216	210	210	210	22	8	---	---	---	6.7
165.1	6.500	2.95	10.71	9.50	9.45	9.45	9.45	0.63	---	M20	M20	M20	15.0
	165.1	75	272	241	240	240	240	16	---	8	8	8	6.8
6	6.625	2.95	10.71	9.50	9.45	9.45	9.45	0.63	¾	---	---	---	15.2
150	168.3	75	272	241	240	240	240	16	8	---	---	---	6.9
8	8.625	4.00	13.50	11.75	11.61	11.61	---	0.87	¾	M20	M20	---	31.9
200	219.1	102	343	298	295	295	---	22	8	8	16	---	14.5
200 JIS	8.516	4.00	13.50	11.75	11.61	11.61	11.42	0.87	---	---	---	M20	30.8
	216.3	102	343	298	295	295	290	22	---	---	---	12	14.0
10	10.750	3.94	16.00	14.25	13.77	14.00	14.00	1.18	7/8	M20	M24	M22	49.6
250	273.0	100	406	362	350	355	355	30	12	12	12	12	22.5
12	12.750	4.45	19.00	17.00	15.75	16.14	---	1.26	7/8	M20	M24	---	65.9
300	323.9	113	483	432	400	410	---	32	12	12	12	---	29.9

Contact Shurjoint for other sizes.

STAINLESS STEEL GROOVED END FITTINGS  
Rev.2025.0318

Model SS-80F Stainless Steel Universal Flange Adapter (flat face)

Nominal Pipe Size	Pipe O.D.	L	X	Y: Flange Drilling				Z	Bolts				Weight
				ANSI 125 / 150	PN 10	PN 16	JIS 10K		ANSI 125 / 150	PN 10	PN 16	JIS 10K	
in	in	in	in	in	in	in	in	in	in	in	in	in	lbs
mm	mm	mm	mm	mm	mm	mm	mm	mm	mm	mm	mm	mm	kg
2	2.375	2.50	6.50	4.75	4.92	4.92	4.72	0.63	5/8	M16	M16	M16	4.4
50	60.3	64	165	121	125	125	120	16	4	4	4	4	2.0
2½	2.875	3.00	7.28	5.50	5.70	5.70	5.50	0.63	5/8	---	---	---	6.4
65	73.0	76	185	140	145	145	140	16	4	---	---	---	2.9
76.1	3.000	3.00	7.28	5.50	5.70	5.70	5.50	0.63	---	M16	M16	M16	6.6
	76.1	76	185	140	145	145	140	16	---	4	4	4	3.0
3	3.500	2.95	7.78	6.00	6.30	6.30	5.90	0.63	5/8	M16	M16	M16	7.5
80	88.9	75	200	152	160	160	150	16	8	8	8	8	3.4
4	4.500	2.95	8.86	7.50	7.09	7.09	6.89	0.63	5/8	M16	M16	M16	8.6
100	114.3	75	225	191	180	180	175	16	8	8	8	8	3.9
139.7	5.500	2.95	10.00	8.50	8.27	8.27	8.27	0.63	---	M16	M16	M20	14.7
	139.7	75	254	216	210	210	210	16	---	8	8	8	6.7
5	5.563	2.95	10.00	8.50	8.27	8.27	8.27	0.87	¾	---	---	---	14.7
125	141.3	75	254	216	210	210	210	22	8	---	---	---	6.7
165.1	6.500	2.95	10.71	9.50	9.45	9.45	9.45	0.63	---	M20	M20	M20	15.0
	165.1	75	272	241	240	240	240	16	---	8	8	8	6.8
6	6.625	2.95	10.71	9.50	9.45	9.45	9.45	0.63	¾	---	---	---	15.2
150	168.3	75	272	241	240	240	240	16	8	---	---	---	6.9
8	8.625	4.00	13.50	11.75	11.61	11.61	---	0.87	¾	M20	M20	---	31.9
200	219.1	102	343	298	295	295	---	22	8	8	16	---	14.5
200 JIS	8.516	4.00	13.50	11.75	11.61	11.61	11.42	0.87	---	---	---	M20	30.8
	216.3	102	343	298	295	295	290	22	---	---	---	12	14.0
10	10.750	3.94	16.00	14.25	13.77	14.00	14.00	1.18	7/8	M20	M24	M22	49.6
250	273.0	100	406	362	350	355	355	30	12	12	12	12	22.5
12	12.750	4.45	19.00	17.00	15.75	16.14	---	1.26	7/8	M20	M24	---	65.9
300	323.9	113	483	432	400	410	---	32	12	12	12	---	29.9

Contact Shurjoint for other sizes.

## General note

- *Pressure Ratings* for fittings conform to the working pressure of the coupling used to join the system.
- Listed and or Approved Pressures are pressure ratings for fire protection systems, tested and approved by various approval bodies. Please always refer to the latest approval data posted on the Shurjoint website.
- Field Joint Test: For one time only, the system may be tested hydrostatically at 1½ times the maximum working pressure listed (AWWA C606 5.2.3).
- Warning: Piping systems must always be depressurized and drained before attempting disassembly and or removal of any components.
- The 10 Year Limited Warranty applies to manufacturing defects only and does not cover severe service/temperature applications or wear parts.
- Shurjoint reserves the right to change specifications, designs and or standard without notice and without incurring any obligations.

**Aalberts integrated piping systems APAC Inc.**

11F-2 No. 175 Zhongzheng 2<sup>nd</sup> Rd. / Lingya, Kaohsiung

Taiwan

[www.aalberts.com/ips](http://www.aalberts.com/ips)